

LAUCO.
seating spaces.



LINEAS DE SOFAS



LÍNEA A 4

Pág 06.



LÍNEA Ceo

Pág 16.



LÍNEA Net

Pág 24.



LÍNEA Off

Pág 32.

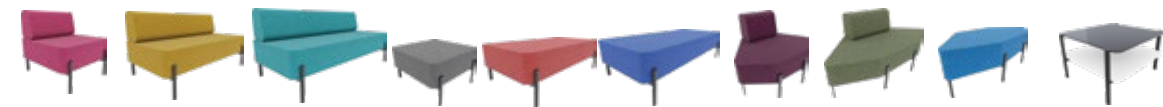

LÍNEA One

Pág 42.

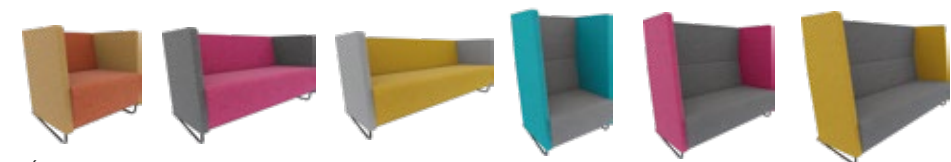

LÍNEA Wem

Pág 52.



LÍNEA Link

Pág 60.



LÍNEA Red

Pág 68.



LÍNEA Lex

Pág 76.



LÍNEA Set

Pág 86.



LÍNEA Tag

Pág 94.

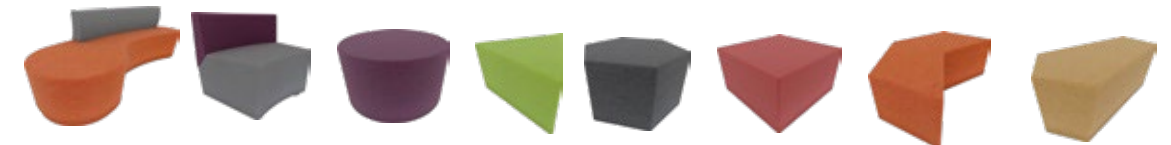

LÍNEA Tab

Pág 102.

A4

Sistema de respaldos altos y bajos

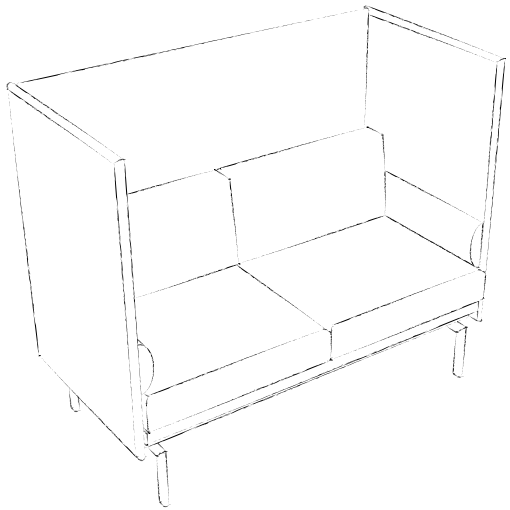

- Estructura interna madera de pino de primera 22 mm sin nudos en puntos críticos, armada con pegamento blanco y grapa de acero 38 mm y ensamble con tornillo pavonado 8 x 2"
- Acojinamiento en asiento, poliuretano flexible densidad 24/35, respaldo densidad 20/35, brazos y costados densidad 17/45, además delcrón laminado cal. 150 para mayor confort.
- Soporte asiento triplay de pino 19 mm ó MDF 18 mm con refuerzos.
- Patas acero tubular ovalado 20 x 40 mm cal. 16 acabado pintura horneada.

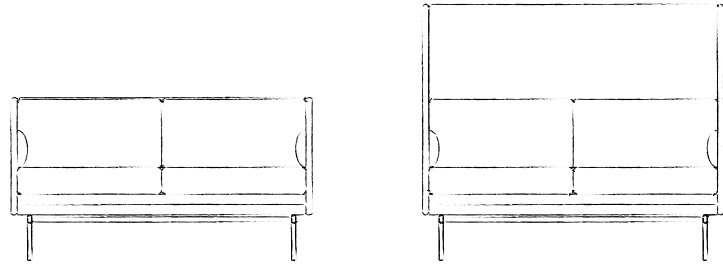





A4 1PRA
.73 X 0.76 X 1.31
SOFA 1 PLAZA BRAZOS Y RESPALDO ALTO



A4 1P
.73 X .76 X .80
SOFA 1 PLAZA BRAZOS Y RESPALDO BAJO



A4 2PRA
.73 X 1.46 X 1.31
SOFA 2 PLAZAS BRAZOS Y RESPALDO ALTO



A4 2P
.73 X 1.46 X .80
SOFA 2 PLAZAS BRAZOS Y RESPALDO BAJO



A4 3PRA
.73 X 1.86 X 1.31
SOFA 3 PLAZAS BRAZOS Y RESPALDO ALTO



A4 3P
.73 X 1.86 X .80
SOFA 3 PLAZAS BRAZOS Y RESPALDO BAJO





A4 1.5PRAM

.73 X 1.16 X 1.31

SOFA 1.5 PLAZA BRAZOS Y RESPALDO ALTO C/MESA DE TRABAJO



A4 CUB 4P

2.36 X 1.46 X 1.31

CUBICULO 2 A4 2PRA + A4 PANEL + CUBIERTA
BALA 19MM 1.40 X .60 + PEDESTAL PINTADO GRIS +
CONECTOR MULTIPUERTO 2 C.A.- 1 USB INCLUYE
HERRAJES PARA ARMAR

Ceo

Sistema tradicional premium

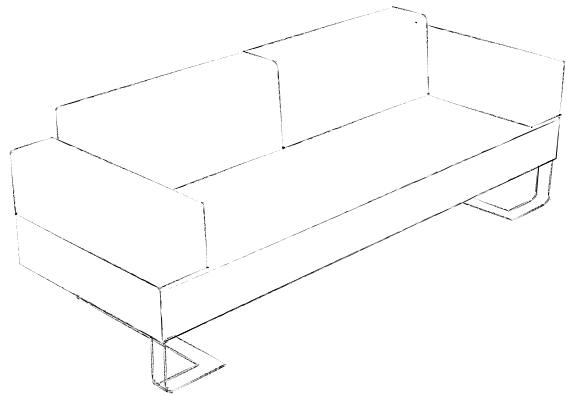

- Estructura interna madera de pino de primera 22 mm sin nudos en puntos críticos, armada con pegamento blanco y grapa de acero 38 mm y ensamble con tornillo pavonado 8 x 2"
- Acojinamiento en asiento, poliuretano flexible densidad 24/35, respaldo densidad 20/35, brazos y costados densidad 17/45, además delcrón laminado cal. 150 para mayor confort.
- Soporte de asiento con resortes alambre cal. 9 zigzag y entramado hilo rafia para trabajo uniforme además tela tipo costal para mayor firmeza.
- Patas solera de acero placa 3/16 x 2 ½ acabado pintura horneada o cromado.

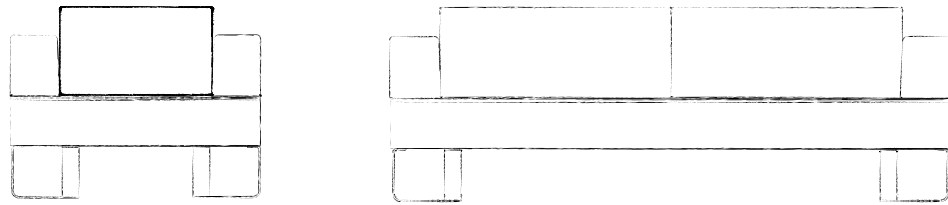





CEO 1P

.81 X 1.01 X .78

SOFA 1 PLAZA (PATAS PINTADAS / CROMADAS)



CEO 2P

.81 X 1.61 X .78

SOFA 2 PLAZAS (PATAS PINTADAS / CROMADAS)



CEO 3P

.81 X 2.21 X .78

SOFA 3 PLAZAS (PATAS PINTADAS / CROMADAS)



Net

Sistema tradicional moderno

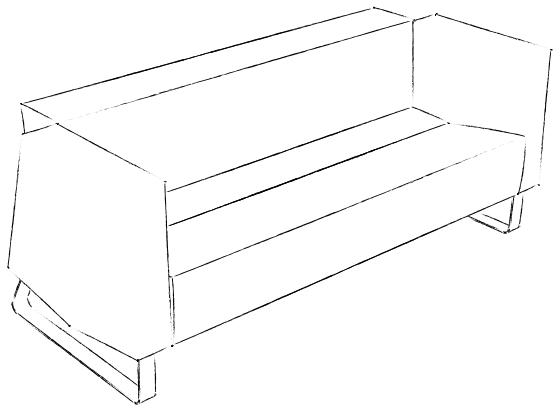

- Estructura interna madera de pino de primera 22 mm sin nudos en puntos críticos, armada con pegamento blanco y grapa de acero 38 mm y ensamble con tornillo pavonado 8 x 2"
- Acojinamiento en asiento tipo sándwich con aglutinado densidad 40 kg y encima espuma flexible densidad 24/35, respaldo densidad 20/35, brazos y costados densidad 17/45. Además, delcrón laminado cal. 150 para mayor confort.
- Soporte de asiento con tiras madera de pino 5 cm x 2 cm y tiras MDF 6 mm formando un tramado uniforme y resistente para mayor duración en alto tráfico.
- Patas solera de acero placa 3/16 x 2 ½ acabado pintura horneada o cromado.

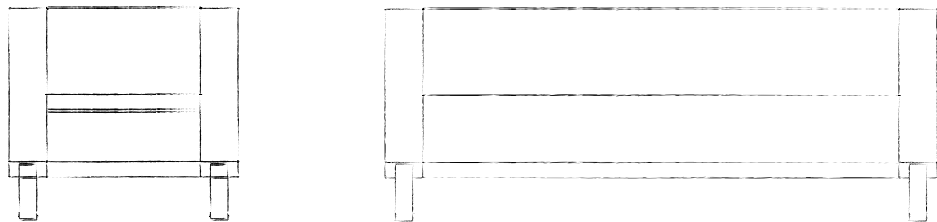





NET 1P

.82 X .85 X .78

SOFA 1 PLAZA (PATAS PINTADAS / CROMADAS)



NET 2P

.82 X 1.45 X .78

SOFA 2 PLAZAS (PATAS PINTADAS / CROMADAS)



NET 3P

.82 X 2.05 X .78

SOFA 3 PLAZAS (PATAS PINTADAS / CROMADAS)



Off

Sistema con diferentes configuraciones

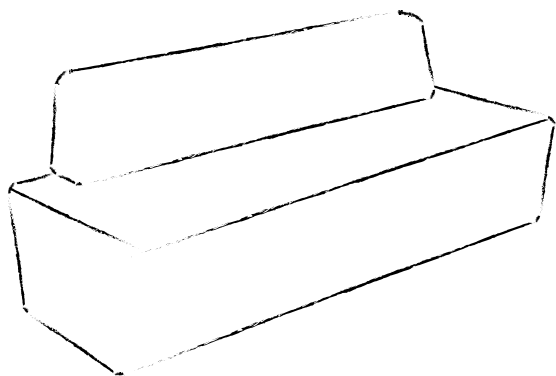

- Estructura interna madera de pino de primera 22 mm sin nudos en puntos críticos, armada con pegamento blanco y grapa de acero 38 mm y ensamble con tornillo pavonado 8 x 2"
- Acojinamiento en asiento poliuretano flexible densidad 24/45, respaldo densidad 20/35 con delcrón laminado cal. 150.
- Soporte asiento triplay de pino 19 mm ó MDF 18 mm con refuerzos.
- Regatón oculto de 1 cm.

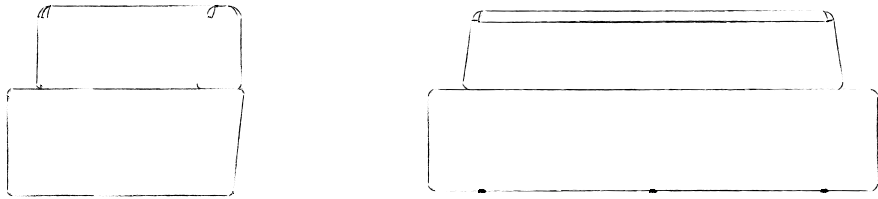





OFF 550
2.00 X .70 X .80
SOFA 3 PLAZAS CON RESPALDO



OFF 552
2.30 X .70 X .80
SOFA CURVO 60° RESPALDO INTERNO



OFF 554
2.30 X .70 X .80
SOFA CURVO 60° RESPALDO EXTERNO



OFF 556
.90 X 1.10 X .46
TABURETE PENTAGONAL



OFF 570
1.50 X .70 X .80
SOFA CURVO 90° RESPALDO INTERNO



OFF 572
1.50 X .70 X .80
SOFA CURVO 90° RESPALDO EXTERNO



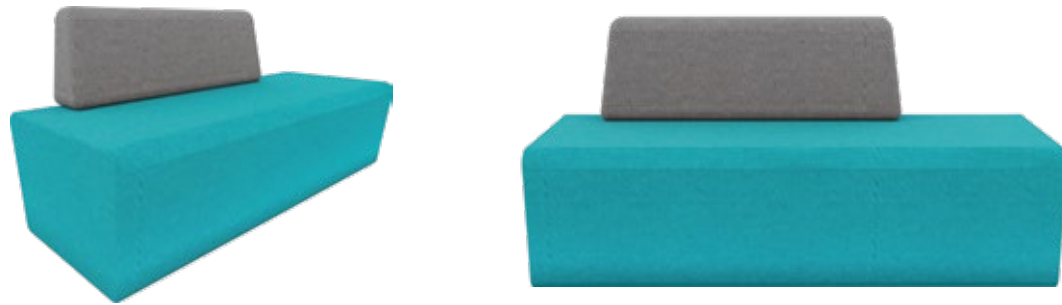

OFF 574 D
1.65 X .70 X .80
SOFA MODULAR DERECHO 2 PLAZAS CON RESPALDO



OFF 574 I
1.65 X .70 X .80
SOFA MODULAR IZQUIERDO 2 PLAZAS CON RESPALDO

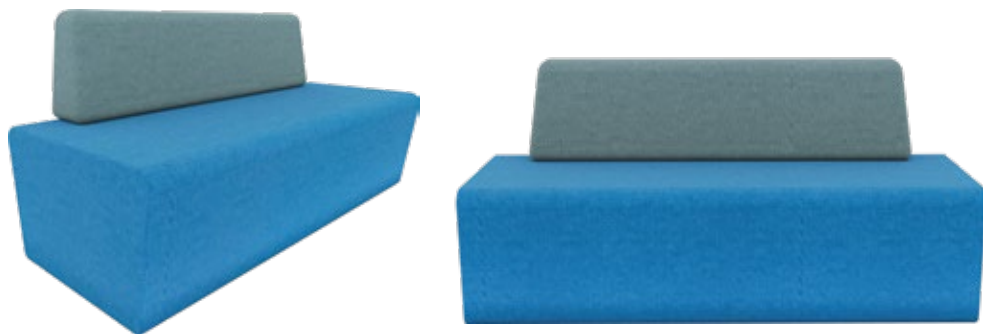

OFF 576
1.65 X .70 X .80
SOFA MODULAR CENTRAL 2 PLAZAS CON RESPALDO



OFF 520
50 X .50 X .45
TABURETE CUADRADO



One

SSistema modular configurable

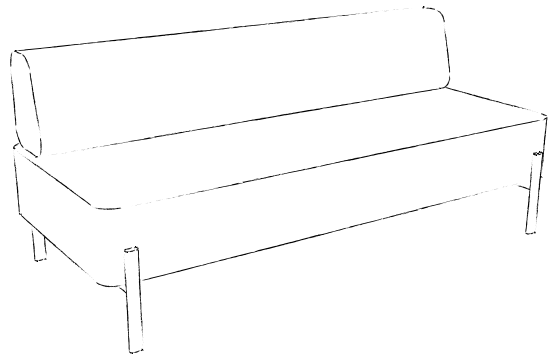

- Estructura interna madera de pino de primera 22 mm sin nudos en puntos críticos, armada con pegamento blanco y grapa de acero 38 mm y ensamble con tornillo pavonado 8 x 2"
- Acojinamiento en asiento, poliuretano flexible densidad 24/45 con delcrón laminado cal. 150, respaldo densidad 20/35
- Soporte asiento triplay de pino 19 mm ó MDF 18 mm con refuerzos.
- Patas estructurales acero tubular ovalado 20 x 40 mm cal. 16 acabado pintura horneada.

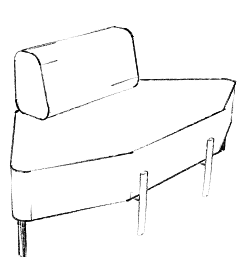

EXT. 90

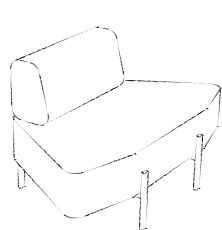

EXT. 60

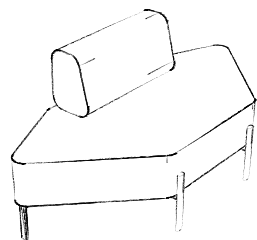

INT. 90

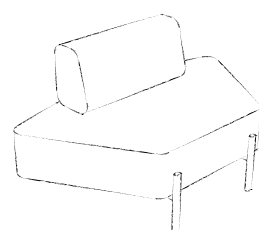

INT. 60







ONE 1P
.75 X .75 X .76
SOFA 1 PLAZA CON RESPALDO



ONE 2P
.75 X 1.50 X .76
SOFA 2 PLAZAS CON RESPALDO



ONE 3P
.75 X 1.80 X .76
SOFA 3 PLAZAS CON RESPALDO



ONE 1P TAB
.75 X .75 X .44
SOFA 1 PLAZA TABURETE SIN RESPALDO



ONE 2P TAB
.75 X 1.50 X .44
SOFA 2 PLAZAS TABURETE SIN RESPALDO



ONE 3P TAB
.75 X 1.80 X .44
SOFA 3 PLAZAS TABURETE SIN RESPALDO





● ONE 60ESQ
.75 X 1.37 X .76
SOFA 1 PLAZA ESQUINERO 60 CON RESPALDO



● ONE 90ESQ
.75 X 1.68 X .76
SOFA 1 PLAZA ESQUINERO 90 CON RESPALDO



ONE 60ESQ TAB
.75 X 1.37 X .44
SOFA 1 PLAZA ESQUINERO 60 SIN RESPALDO



ONE 90ESQ TAB
.75 X 1.68 X .44
SOFA 1 PLAZA ESQUINERO 90 SIN RESPALDO



ONE MESA
.75 X .75 X .44
MESA MELAMINA Y CRISTAL TEMPLADO 9MM

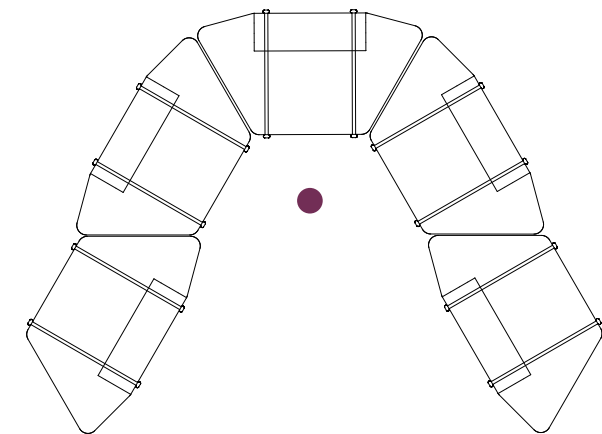
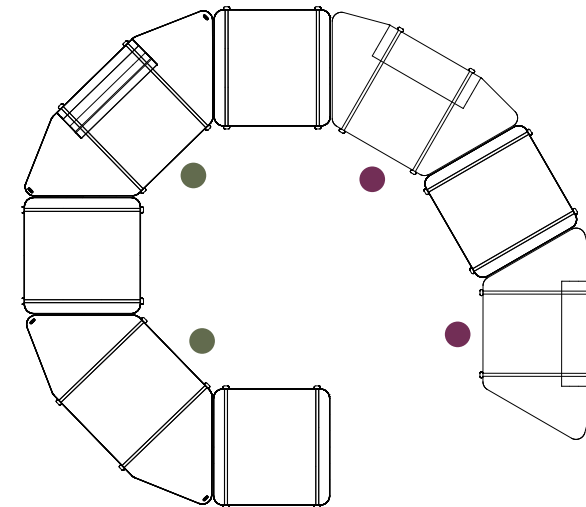

DIFERENTES TIPOS DE CONFIGURACIONES



Wem

Sistema de cabinas para privacidad y convencional

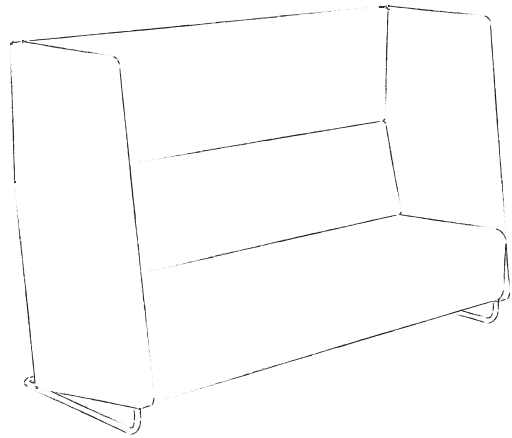

- Estructura interna madera de pino de primera 22 mm sin nudos en puntos críticos, armada con pegamento blanco y grapa de acero 38 mm y ensamble con tornillo pavonado 8 x 2"
- Acojinamiento en asiento poliuretano flexible densidad 24/35, respaldo densidad 20/35 brazos y costados densidad 17/45, además del crón laminado cal. 150 para mayor confort.
- Soporte de asiento con tiras madera de pino 5 cm x 2 cm y tiras MDF 6mm formando un tramado uniforme y resistente para mayor duración en alto tráfico.
- Patas contorno acero tubular redondo 1" cal. 16, acabado pintura homeada o cromado.

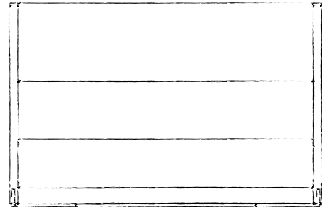
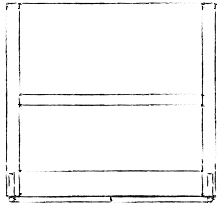





WEM 1P
.72 X .77 X .75
SOFA 1 PLAZA BRAZOS Y RESPALDO BAJO



WEM 1PRA
.72 X .77 X 1.23
SOFA 1 PLAZA BRAZOS Y RESPALDO ALTO



WEM 2P
.72 X 1.42 X .75
SOFA 2 PLAZAS BRAZOS Y RESPALDO BAJO



WEM 2PRA
.72 X 1.42 X 1.23
SOFA 2 PLAZAS BRAZOS Y RESPALDO ALTO



WEM 3P
.72 X 1.92 X .75
SOFA 3 PLAZAS BRAZOS Y RESPALDO BAJO



WEM 3PRA
.72 X 1.92 X 1.23
SOFA 3 PLAZAS BRAZOS Y RESPALDO ALTO



Link

Sistema con diferentes configuraciones

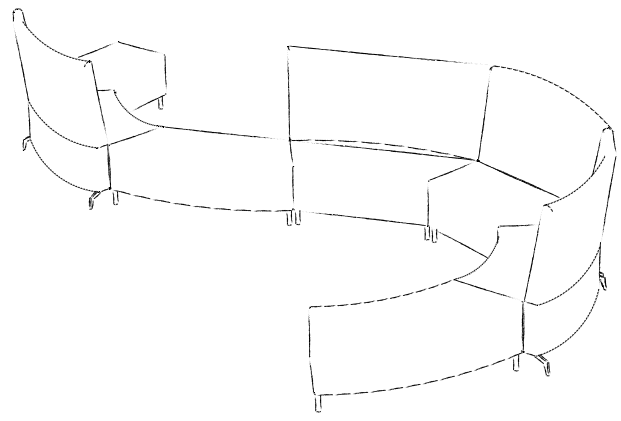

- Estructura interna madera de pino de primera 22 mm sin nudos en puntos críticos, armada con pegamento blanco y grapa de acero 38 mm y ensamble con tornillo pavonado 8x 2"
- Acojinamiento asiento, poliuretano flexible densidad 24/45, respaldo densidad 20/35 con delcrón laminado cal. 150.
- Soporte asiento triplay de pino 19 mm ó MDF 18 mm con refuerzos.
- Patas metálicas importadas acabado negro mate o cromo.

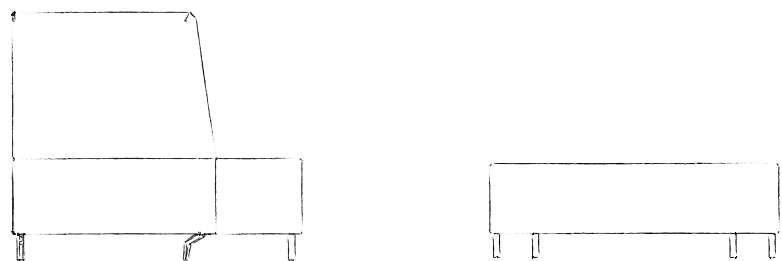





LINK CR EXT
1.40 X .75 X 1.10
SOFA CURVO CON RESPALDO EXTERNO



LINK CR INT
1.20 X .75 X 1.10
SOFA CURVO CON RESPALDO INTERNO



LINK TAB
1.20 X .55 X .44
SOFA CURVO SIN RESPALDO



Red

Sistema tradicional moderno

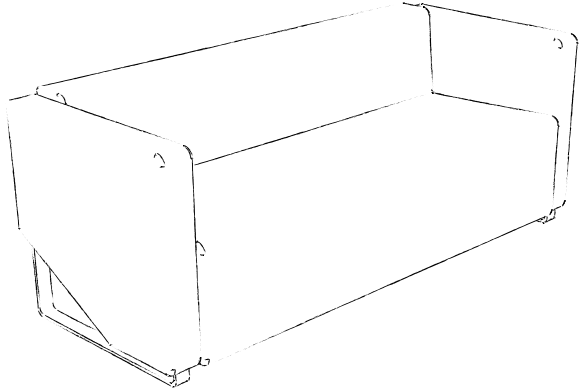

- Estructura interna madera de pino de primera 22 mm sin nudos en puntos críticos, armada con pegamento blanco y grapa de acero 38 mm y ensamble con tornillo pavonado 8 x 2"
- Acojinamiento en asiento tipo sándwich con aglutinado densidad 40 kg y encima espuma flexible densidad 24/35, respaldo densidad 20/35, brazos y costados densidad 17/45. Además, delcrón laminado cal. 150 para mayor confort.
- Soporte de asiento con tiras madera de pino 5 cm x 2 cm y tiras MDF 6 mm formando un tramado uniforme y resistente para mayor duración en alto tráfico.
- Patas solera de acero placa 3/16 x 2 ½ acabado pintura horneada.

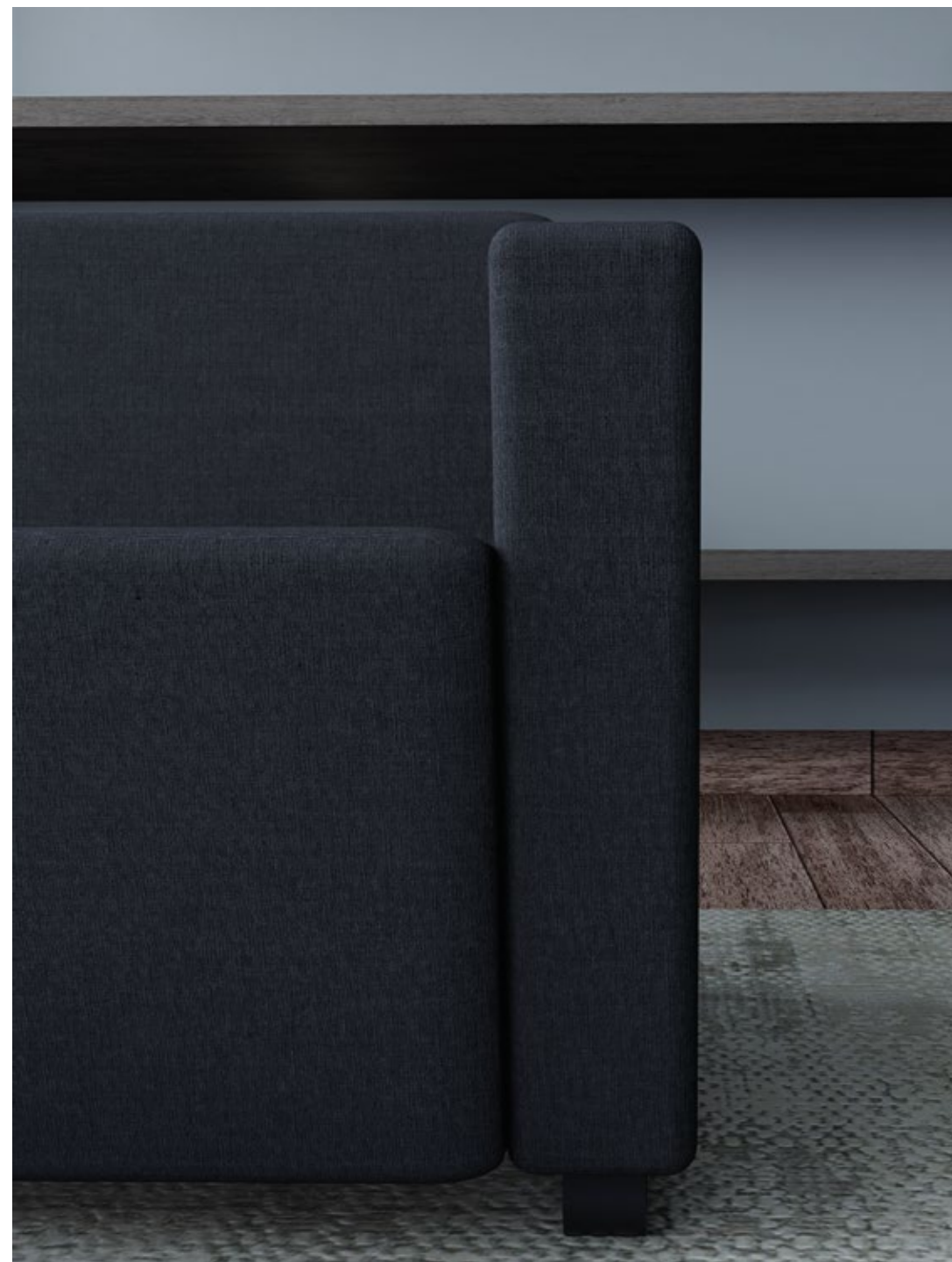
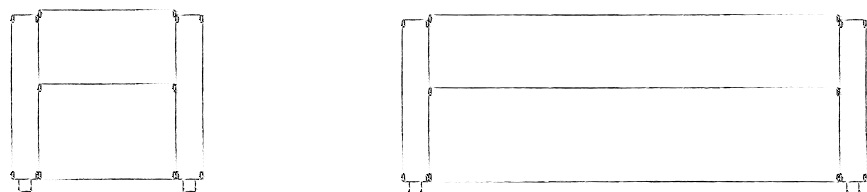





RED 1P
.75 X .78 X .72
SOFA 1 PLAZA (PATAS PINTADAS)



RED 2P
.75 X 1.35 X .72
SOFA 2 PLAZAS (PATAS PINTADAS)



RED 3P
.75 X 1.92 X .72
SOFA 3 PLAZAS (PATAS PINTADAS)



Lex

Sistema modular colaborativo

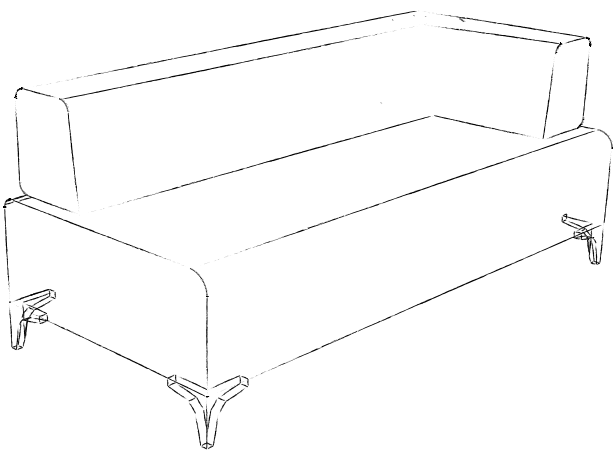

- Estructura interna madera de pino de primera 22 mm sin nudos en puntos críticos, armada con pegamento blanco y grapa de acero 38 mm y ensamble con tornillo pavonado 8 x 2"
- Acojinamiento en asiento tipo sándwich con aglutinado densidad 40 kg y encima espuma flexible densidad 24/35, respaldo densidad 20/35, brazos y costados densidad 17/45. Además, delcrón laminado cal. 150 para mayor confort.
- Soporte de asiento con tiras madera de pino 5 cm x 2 cm y tiras MDF 6 mm formando un tramado uniforme y resistente para mayor duración en alto tráfico.
- Patas metálicas importadas en color negro mate o cromo.

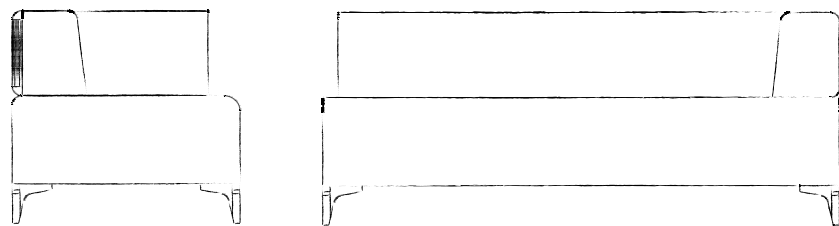





LEX 75CR
 .75 X .75 X .72
 SOFA 1 PLAZA (CON RESPALDO SIN BRAZOS)



LEX 75TAB
 .75 X .75 X .43
 BANCA TABURETE 1 PLAZA (SIN RESPALDO)



LEX 130CR
 .75 X 1.30 X .72
 SOFA 2 PLAZAS (CON RESPALDO SIN BRAZOS)



LEX 130TAB
 .75 X 1.30 X .43
 BANCA TABURETE 2 PLAZAS (SIN RESPALDO)



LEX 170CR
 .75 X 1.70 X .72
 SOFA 3 PLAZAS (CON RESPALDO SIN BRAZOS)



LEX 170TAB
 .75 X 1.70 X .43
 BANCA TABURETE 3 PLAZAS (SIN RESPALDO)





LEX 75ESQ
 .75 X .75 X .72
 SOFA 1 PLAZA (ESQUINERO IZQ O DER)



LEX 130ESQ
 .75 X 1.30 X .72
 SOFA 2 PLAZAS (ESQUINERO IZQ O DER)



LEX 170ESQ
 .75 X 1.70 X .72
 SOFA 3 PLAZAS (ESQUINERO IZQ O DER)



Set

Sistema tradicional convencional

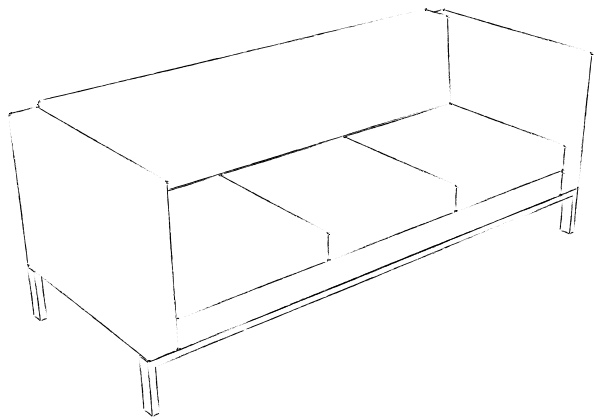

- Estructura interna madera de pino de primera 22 mm sin nudos en puntos críticos, armada con pegamento blanco y grapa de acero 38 mm y ensamble con tornillo pavonado 8 x 2"
- Acojinamiento en asiento tipo sándwich con aglutinado densidad 40 kg y encima espuma flexible densidad 24/35, respaldo densidad 20/35, brazos y costados densidad 17/45. Además, delcrón laminado cal. 150 para mayor confort.
- Soporte de asiento con bandastic entramado en ambos sentidos reforzado de 7 cms.
- Base tubular 2 ¼ x ¾ acabado pintura horneada.

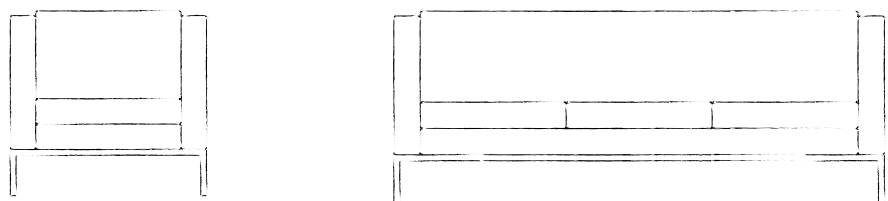





SET 1P

.82 X .85 X .78

SOFA 1 PLAZA (PATAS PINTADAS)



SET 2P

.82 X 1.45 X .78

SOFA 2 PLAZAS (PATAS PINTADAS)

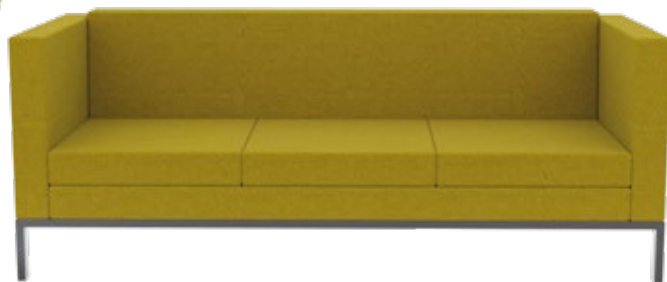

SET 3P

.82 X 2.05 X .78

SOFA 3 PLAZAS (PATAS PINTADAS)



Tag

Sistema modular básico

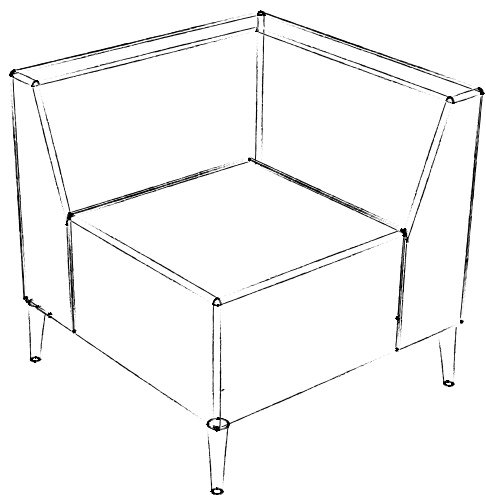

- Estructura interna madera de pino de primera 22 mm sin nudos en puntos críticos, armada con pegamento blanco y grapa de acero 38 mm y ensamble con tornillo pavonado 8 x 2"
- Acojinamiento en espuma flexible densidad 24/35, respaldo densidad 20/35, brazos y costados densidad 17/45. Además, delcrón laminado cal. 150 para mayor confort.
- Soporte de asiento con bandastic entramado en ambos sentidos reforzado de 7 cms.
- Patas en acero tubular redondo conificado en color negro mate o cromo.

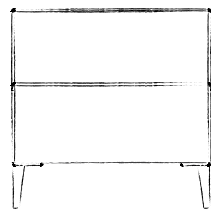
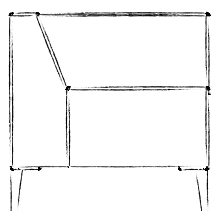





TAG 1C CENTRAL

.70 X .70 X .70

SOFA MODULAR 1 PLAZA (SOLO RESPALDO)



TAG 1E ESQUINERO

.70 X .70 X .70

SOFA MODULAR 1 PLAZA (BRAZO Y RESPALDO)



TAG 1T TABURETE

.70 X .70 X .43

SOFA 1 PLAZA (SIN BRAZO, SIN RESPALDO)



Complementos

Drop / Tab / Pol / Sku

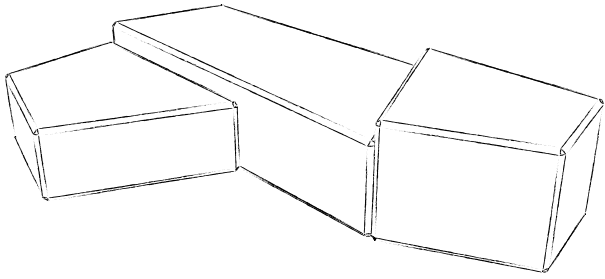

DROP

- Estructura interna madera de pino de primera 22 mm sin nudos en puntos críticos y triplay de pino 19 mm armada con pegamento blanco y grapa de acero 38 mm y ensamble con tornillo pavonado 8 x 2", MDF 3 mm en curvas externas.
- Acojinamiento en asiento poliuretano flexible densidad 24/45, respaldo densidad 20/35 con delcrón laminado cal. 150.
- Soporte de asiento triplay de pino o MDF 18 mm con refuerzos.
- Regatón plástico de 1 cm altura color negro.

SKU

- Estructura interna madera de pino de primera 22 mm sin nudos en puntos críticos y triplay de pino 19 mm armada con pegamento blanco y grapa de acero 38 mm y ensamble con tornillo pavonado 8 x 2", MDF 3 mm en curvas externas.
- Acojinamiento en asiento poliuretano flexible densidad 24/45, respaldo densidad 20/35 con delcrón laminado cal. 150.
- Soporte de asiento con tiras madera de pino 5 cm x 2 cm y tiras MDF 6 mm formando un tramado uniforme y resistente para mayor duración en alto tráfico.
- Regatón plástico de 1 cm altura color negro.

TAB REDONDO, TRIANGULAR, HEXAGONAL O CUADRADO, POL, ARROW y COFFEE

- Estructura interna madera de pino de primera 22 mm sin nudos en puntos críticos y triplay de pino 19 mm armada con pegamento blanco y grapa de acero 38 mm, MDF 3 mm en curvas externas.
- Acojinamiento en asiento poliuretano flexible densidad 24/45 con delcrón laminado cal. 150.
- Soporte de asiento triplay de pino o MDF 18 mm con refuerzos.
- Regatón plástico de 1 cm altura color negro.

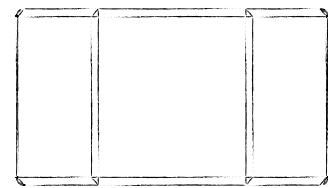
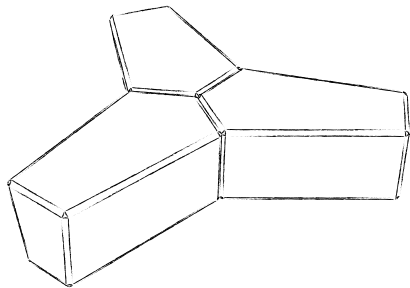





DROP
2.50 X .90 X .78
SOFA DROP 3 PLAZAS



SKU 1
.57 X .91 X .75 X .72
1 PLAZA 60 GRADOS



TAB 50
.50 X .50 X .45
TABURETE REDONDO
OPCIONALMENTE CON RODAJAS



TAB 50
.50 X .50 X .45
TABURETE TRIANGULAR
OPCIONALMENTE CON RODAJAS



TAB 50
.50 X .50 X .45
TABURETE HEXAGONAL
OPCIONALMENTE CON RODAJAS



TAB 50
.50 X .50 X .45
TABURETE CUADRADO
OPCIONALMENTE CON RODAJAS





TAB 80
.80 X .80 X .45
TABURETE REDONDO



TAB 80
.80 X .80 X .45
TABURETE TRIANGULAR



TAB 80
.80 X .80 X .45
TABURETE HEXAGONAL

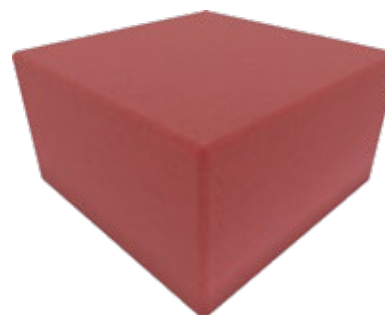

TAB 80
.80 X .80 X .45
TABURETE CUADRADO



ARROW
1.22 X .61 X .45
TABURETE MODULAR SIMETRICO



COFFEE
1.06 X .61 X .45
TABURETE MODULAR SIMETRICO



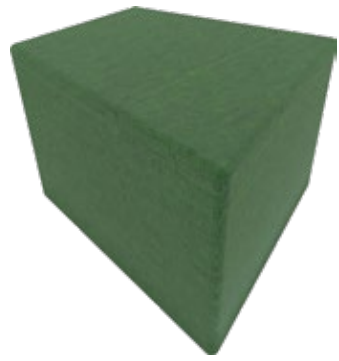

POL 80
.80 X .80 X .55
TABURETE POLIGONO IRREGULAR



POL 100
.90 X 1.00 X .35
TABURETE POLIGONO IRREGULAR



POL 180
.80 X 1.80 X .45
TABURETE POLIGONO IRREGULAR



ACABADOS TELAS

ADDISON

INSTRUCCIONES DE LIMPIEZA

Estas telas se pueden limpiar suavemente con agua, acetona, diluyente, gasolina blanca, jabón en pasta, detergente líquido o en polvo o quitamanchas. Después de limpiar, enjuague con agua limpia para eliminar los residuos de los productos de limpieza.



Brown



Capuchino



Tabaco



Chocolate



Plomo



Gris



Plata



Silver



Platino



Fiusha



Marfil



Camello



Mist



Granito



Uva



Rojo



Shedron



Orange



Mango



Pera



Verde Hoja



Turquesa



Plumbago





Design Center Furniture

Av. García Lavín Plaza Bon Amí Local 4
Col. San Antonio Cucul Mérida, Yucatán

Tel: 999.948.96.36

Cel: 999.117.95.36

www.mueblesmerida.com

ventas@mueblesmerida.com